



**MDSP10**  
**DIGITAL SIGNAL PROCESSOR**

**INDEX**







1. PRODUCT DESCRIPTION-PRECAUTIONARY NOTES.....02  
 2. PACKAGING CONTENTS.....02  
 3. DSP AND DRC INSTALLATION.....03  
 4. INPUT SIGNALS .....04  
 5. GUI OPERATION INSTRUCTION.....05-06  
 6. INTERFACE INTRODUCTION ..... 07-10  
 7. REMOTE INTRODUCTION.....10  
 8. TECHNICAL FEATURES.....11

**1.PRODUCT DESCRIPTION-PRECAUTIONARY NOTES**

The DSP is a digital signal processor essential to maximize the acoustic performance of your car audio system. It consists of a 32-bit DSP processor and 24-bit AD and DA converters. It can connect to any factory system, even in vehicles featuring an intergrated audio processor, since, thanks to the De-equalization function, the DSP will send back a linear signal. It features selectable High and low level inputs as digital inputs that feed 8 completely variable output channels. Each output channel has a 31-band equalizer available. it also features a 66-frequency electronic crossover as well as . BUTTERWORTH or LINKWITZ filters with 6-24dB slopes and a digital time delay line. the user can select adjustments. That allow him or her to interact with the DSP through a remote control device called DRC.

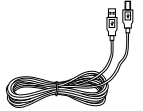
**WARNING:** 1-a PC provided with Windows XP, Windows operating system, 1.5GHz minimum. Processor speed , 1 GB RAM minimum memory and a graphics card with a minimum resolution. Of 1024x600 pixels are required to install the software and setup the DSP.  
 2-Before connecting you DSP, carefully read this manual .Improper connections may cause damage to The DSP or to the speakers in the car audio system.

**2.PACKAGING CONTENTS**

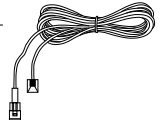
- DSP- Signal Interface Processor 
- Power supply cable Inputs/speaker output 
- 5.0m USB cable 
- Control High Level /wifi Input 
- 4 of 4.0\*15 mm/8of 3.0\*6mm self-tapping, Cross-head fixing screws, 
- OPTIONAL:**
- DRC(Digital Remote Control)control panel: 
- 5.0 m DRC-AC Link cable 

### 3. DSP AND DRC INSTALLATION

#### External dimensions

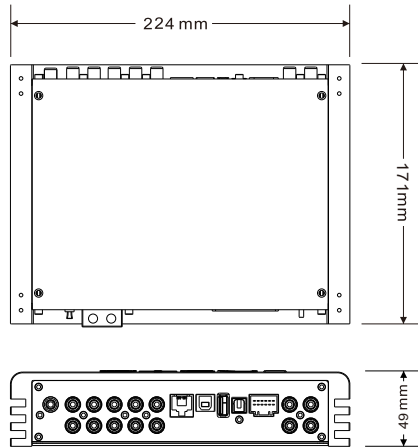

#### How to install



**WARNING:** do not use aggressive cleaning agents or abrasive cloth to clean the display. Simply use a soft cotton cloth lightly dampened with water.

### 4. INPUT SIGNALS

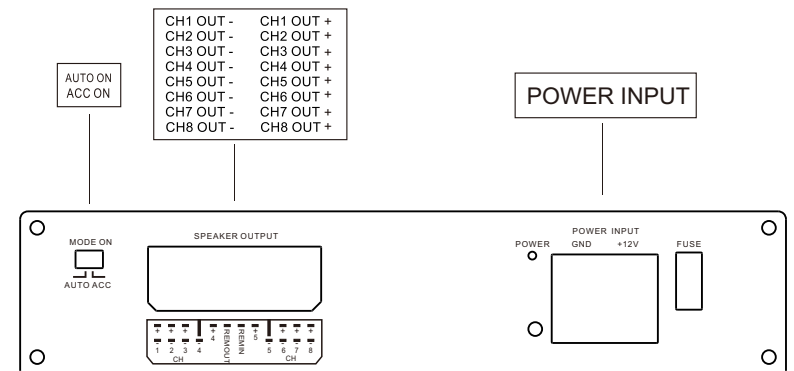
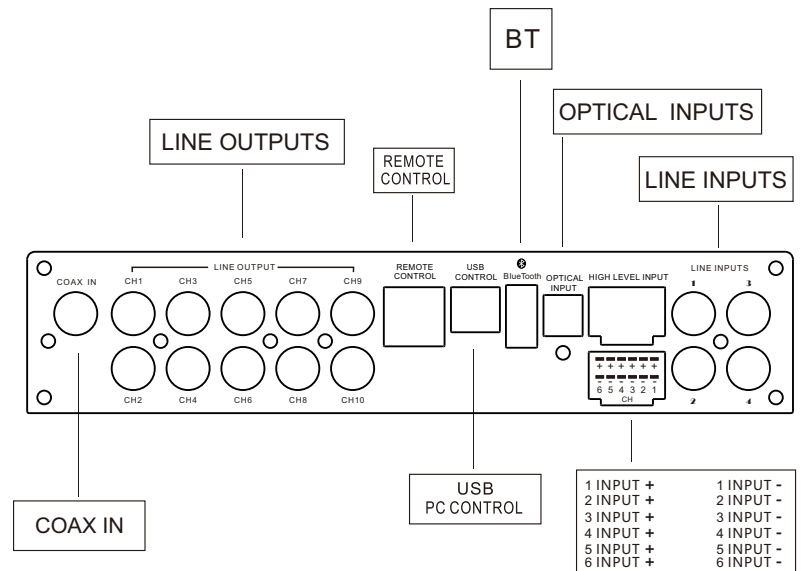

### 5. GUI OPERATION INSTRUCTION

Guide to GUI after installation

#### 1. Double - click icon of STEG



2. Enter the GUI you long for! Now you could tone every signal details as experts do  
To bring sound effect on your beloved car to a higher level.If the password has been set,  
You need to enter the password.

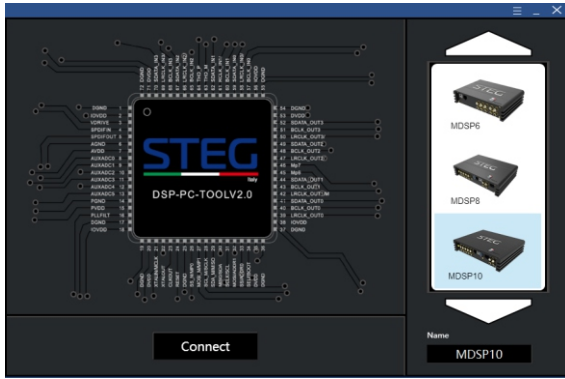

### 6. INTERFACE INTRODUCTION

#### 6.1 MiX



#### 6.2 INPUT EQ

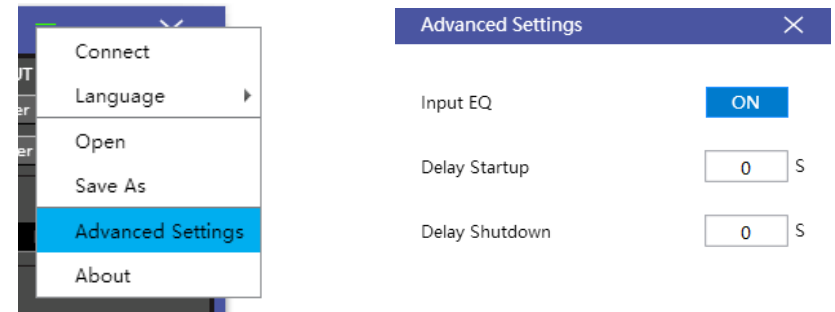

1. Connect
2. Language
3. Open
4. Save As
5. Advanced Settings
6. About

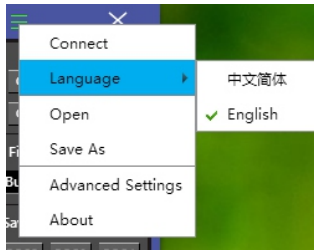

7. Modify Password

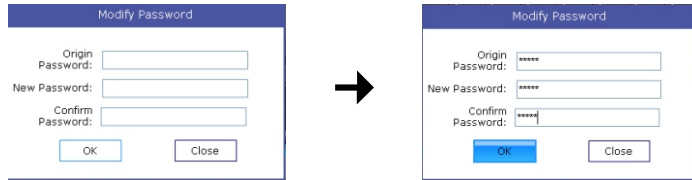

7.3

1. INPUT MODE.

To select different input devices.

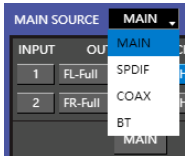

2. CHANNEL SETTING.

① CH mode(2CH 4CH 6CH ).

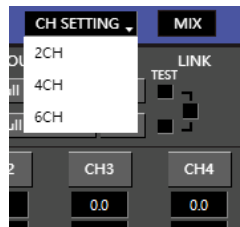

3. CROSSOVER X-TPE.

To choose different crossover type, for example select CH selection on 3RD spot .that would locate CH you want to choose for crossover configuration .



4. CROSS OVER FREQUENCY.

Set frequency of LP/HP individually .

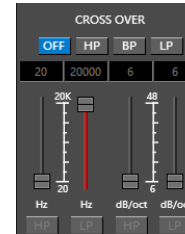

5. GAIN.

0--40dB is optional range for gain control kf every CH.

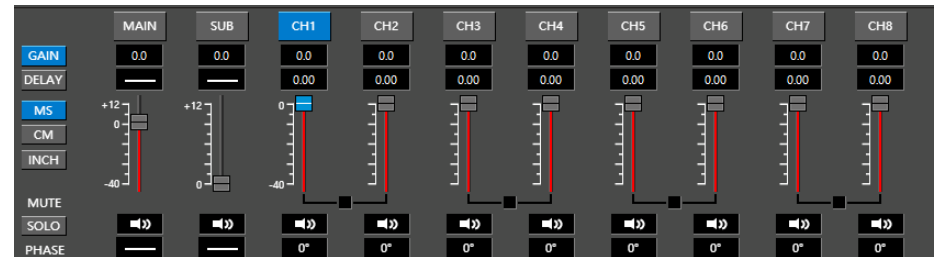

6. DELAY.

1.Auto configuration(base on 1.5 setting).

2.Manual configuration, change specifications in selected CH manually.

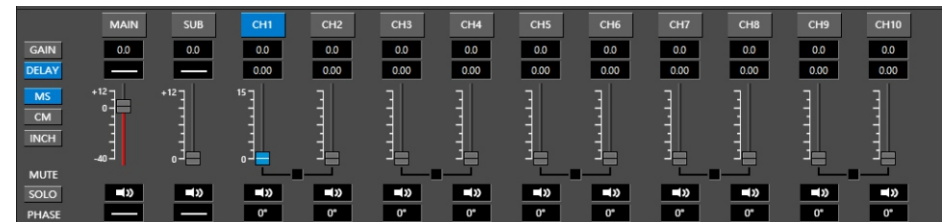

7. LP/SLOPE.

1.6dB/oct 12dB/oct 18dB/oct 24dB/oct 30dB/oct 36dB/oct. 42dB/oct 48dB/oct are available.

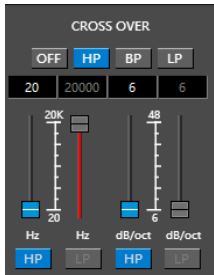

8. HP/SLOPE.

1.6dB/oct 12dB/oct 18dB/oct 24dB/oct 30dB/oct 36dB/oct. 42dB/oct 48dB/oct are available.

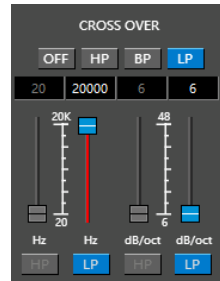

9. Filter Model.

To choose different Filter type Linkwitz Bessel Butterworth.

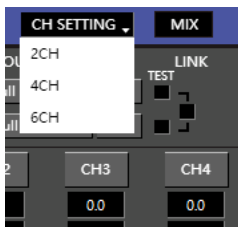

10. WRITE.

To Write To Device(POS1-POS8).

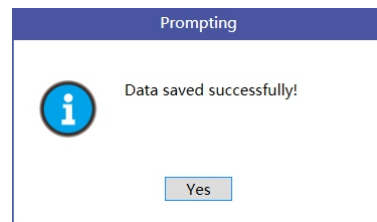
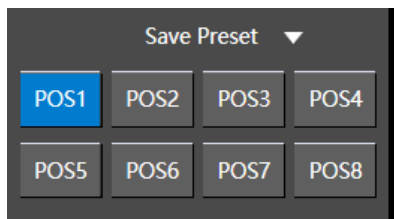

11. READ.

To Read From Device(POS1-POS8).

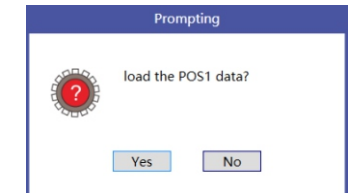
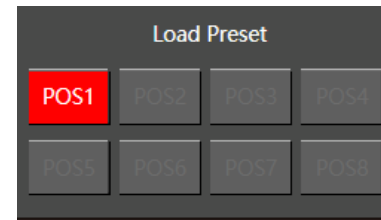

12. X-OVER AND EQ CHARTS.

- 1.Red lines and slopes will change accordingly when HP/LP of crossover and EQ are modified.
- 2.EQ all frequency points can be move left or right.For 20Hz-20KHz can be any Regulation.

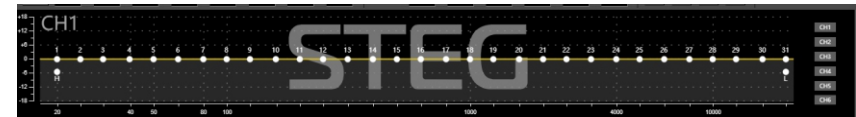

13. EQ SETTING.

Q value=1-12.

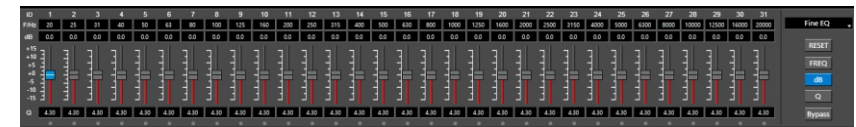

7.REMOTE INTRODUCTION



1. A.Main volume.
- B. When you press this button for a short time, It is in the "MUTE" state. And the close "MUTE".
- C. When you press this button for a longer time (for a second), It will enter the menu mode. In the "MODE" or "INPUT" flashing. You can adjust the mode which you want.
2. Main volume display window.
3. DSP mode display window (1-8).
4. Input display status. (CD, SPDIF, WIFI).

8. TECHNICAL FEATURES

**POWER SUPPLY**

Voltage	9-16VDC
Idling current	1.5A

**SIGNAL STAGE**

Bandwith @-3 dB	10-20kHz
S/N ratio Full Power A-	>100 dB
Hight level input range	3V-15V
THD+N VS Power 1%	(CH1 CH2 CH3 CH4 CH5 CH6 CH7 CH8 ) 8X50W ATTS
Line Output	10channel RCA audio

**INPUT STAGE**

High Level(Speaker)	1.2.3.4.5.6
---------------------	-------------

**CONNECTION**

From/To Personal Computer	1 x USB/B(1.1/2.0) 5M
---------------------------	-----------------------

**CROSSOVER N.5(one each output channel)**

Filter Type	Full/High/Low Pass /Band Pass
Slope Setting	6/12/18/24/30/42/48 dB
Crossover frequency	68 steps @ 20- 20kHz
Phase control indepent setting for each channel	0 - 180°